

**VARIO** BY

**VELUX**<sup>®</sup>

[vario.velux.com](http://vario.velux.com)

**Bespoke Flat Rooflights**  
Imagined by you, built with Vario by VELUX

Version 4.0

# World-class Bespoke Flat Rooflights

Vario by VELUX is the Bespoke, Flat Rooflight range from the VELUX Group. Combining 80 years of expertise, with contemporary, functional design resulting in seamless, sweeping views of the skies above. Design your Rooflights just the way you want them and uncover endless product variations, with the help of our Daylight Experts.

## Customisation Matters

You want your house to reflect your tastes, to incorporate a truly personal touch. So do we.

## Includes Insulated Upstand

Fixed or Opening Rooflight? Thanks to our elegant design, motors for our Opening Rooflights are pre-installed in our Upstand. There is no visible difference internally, between a Fixed or Opening Product.

## Full Service Provider

Whether you need tools for visualising your dream project, finding a professional for your building project (Installer or Contractor), or you would like a full Supply and Fit service, we are here to help.

## Smart Roller Blinds

The Vario by VELUX smart roller blinds, are supported by thin wires to create an invisible effect, designed to provide privacy and diffuse light. Option to pre-fit blinds prior to delivery.

## Clear Internal Measurement

What you see, is what you get. Our quoted size is the total amount of visible glass you will receive.

## Daylight Experts

Our Daylight Experts are always on hand to help. Book a consultation and discuss your daylight needs.

## 10 Years Guarantee

We never promise more than we can deliver but we think it's always ok to deliver more than we promise.



# Discover **Endless Possibilities** of Light

Learn about all the different ways that you can design with daylight using Vario by VELUX Rooflights. Explore how you can bring your daylight dreams to life, with a huge variety of shapes and features, creating the ultimate blend of natural light for your home. Available in two external colours Jet Black (RAL 9005), Traffic Grey (RAL 7043).

<b>Did you know that ...</b>	<b>4</b>
<b>Explore endless possibilities and combinations</b>	<b>6</b>
The <b>Long Slim</b> Rooflight	<b>8</b>
The <b>Rectangular</b> Rooflight	<b>10</b>
The <b>Square</b> Rooflight	<b>12</b>
The <b>Unlimited</b> Rooflight	<b>13</b>
The <b>Walk-on</b> Rooflight	<b>15</b>
The <b>Round</b> Rooflight	<b>17</b>
The <b>Bespoke</b> Smart Blinds	<b>19</b>
<b>Build your own rooflight</b> (Our configurator)	<b>21</b>
<b>Daylight Design Services</b>	<b>23</b>
<b>Architect suite and specifications</b>	<b>25</b>
<b>Sectional drawings and installation</b>	<b>27</b>
<b>Product construction and limitations</b>	<b>29</b>
<b>Product add ons and the tech stuff</b>	<b>31</b>
<b>Trust Trustpilot</b>	<b>37</b>
<b>Contact us</b>	<b>38</b>

# Did You Know That ...



1

We spend **90% of our time indoors** and we spend 2/3 of that time in our homes – **that calls for healthy and well lit homes.**



2

The typical **4 person family** produces **8-10 litres of moisture** during a day, which calls for well-ventilated homes.



3

Hot air rises, thus the **best way to ventilate** warm air and steam is **through the rooflight** – we call it the stag effect.



4

We recommend that you have **20% glazing compared to the floor area** in a room.



5

A **rooflight provides twice as much daylight** as the same size façade element.

“ With products like Vario by VELUX, utilising varying rooflight shapes, sizes and positionings is easy, and we are able to respond to client needs, define textures and create beautiful spaces that go far beyond the ordinary.

**Annabelle Tugby,**  
Founder of Annabelle Tugby Architects





“ I get up for work very early, about 6am, and before having these windows, the room was just hot and you could feel the lack of air, now, when I come down [the window has been open](#) and it makes a difference. It's made the whole house cool.

We now have a movement of air through the house that we didn't have before. I think it's a really lovely way to be connected to the outside you see the seasons change, you can watch the roof splatter with raindrops my daughter loves watching that when it happens and the bifold doors plus rooflights really make this an integrated room with the garden. You have a bit of the outdoors inside here.”

**Sebastian Alasino**  
London, UK

“ 'Our old kitchen was so dark and now we have had the extension with the Vario by VELUX Rooflights put in, it is so light and bright and they have created a lovely airy feeling in the room.

We sat down with the Architect to discuss designing with daylight and brining the outside in, from there I decided on the Flat Rooflights, because they are more modern. I really like the fact that it is uninterrupted views up to the sky, I love it.

On Vario by VELUX Website you can input the dimensions you want and it just builds it there on the screen, in 3D!

Because I work from home I wanted to create a nice light space that would energise me and start the day, the Rooflights have definitely added to that. As soon as they were installed I said wow, this is exactly what I wanted to achieve.'

**Jennifer Griffin**  
Derby, UK

“ The first thing I noticed when this large piece of glass went in was the bigger expansive light. Even on a cloudy day it makes the room much brighter and you don't have to put on lights. It's always there. You come down in the morning and all this light is filled in this room. It's absolutely beautiful. Around lunch time the light shines on my chair, it's an excellent place to have a little snooze in the sun.

I had such a good experience, everything was done so professionally. Vario by VELUX worked with us and what we had and they had to make a few adjustments but that was done unobtrusively and the end product is beautiful.

**Anna van Heerden**  
Hertfordshire, UK

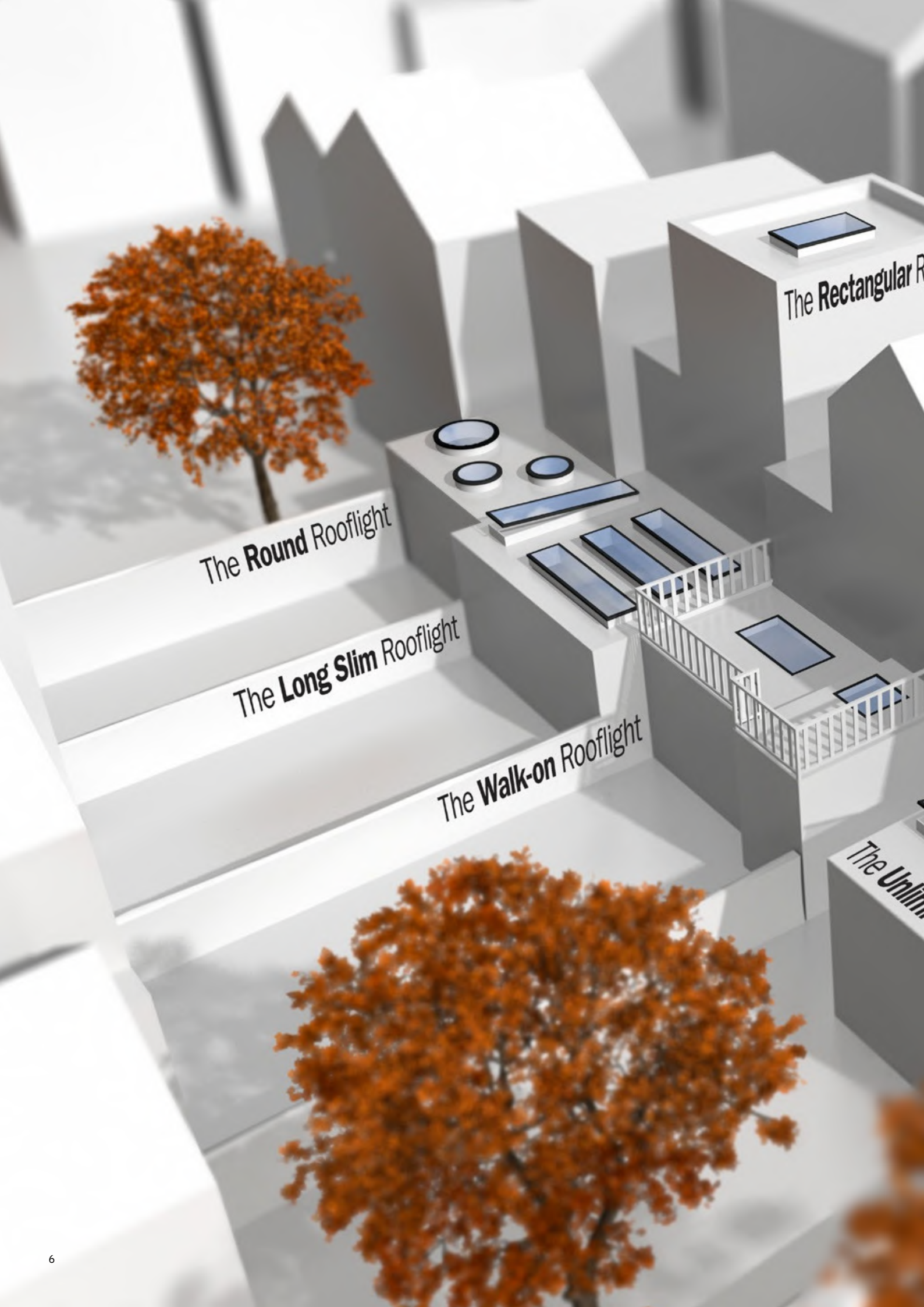

The **Round** Rooflight

The **Long Slim** Rooflight

The **Walk-on** Rooflight

The **Rectangular** Rooflight

The **Unlin**

ooflight

The *Square* Rooflight

imited Rooflight

**Explore Endless Possibilities**  
and Combinations

# The **Long Slim** Rooflight



This roof window design is sleek, elegant and with a unique ability to diffuse daylight, creating a soft yet distinctive look. Multiple long window units can be combined along the length of a room for a truly dramatic, striking effect that creates a stunning ambient light effect and transforms the entire character of your space.

Your long window can be customised to include the optimal blend of features for your home, such as motorised ventilation, superior insulating glass, a walk-on feature and much more.



## Create a daylight waterfall

Creates a stunning diffused daylight effect and transforms the entire character of your space with dramatic light beams pouring in along the length of a room.



From

**£1,115\***

\*250 mm x 1000 mm, double layer IGU and 150 mm upstand. Excl. Delivery.



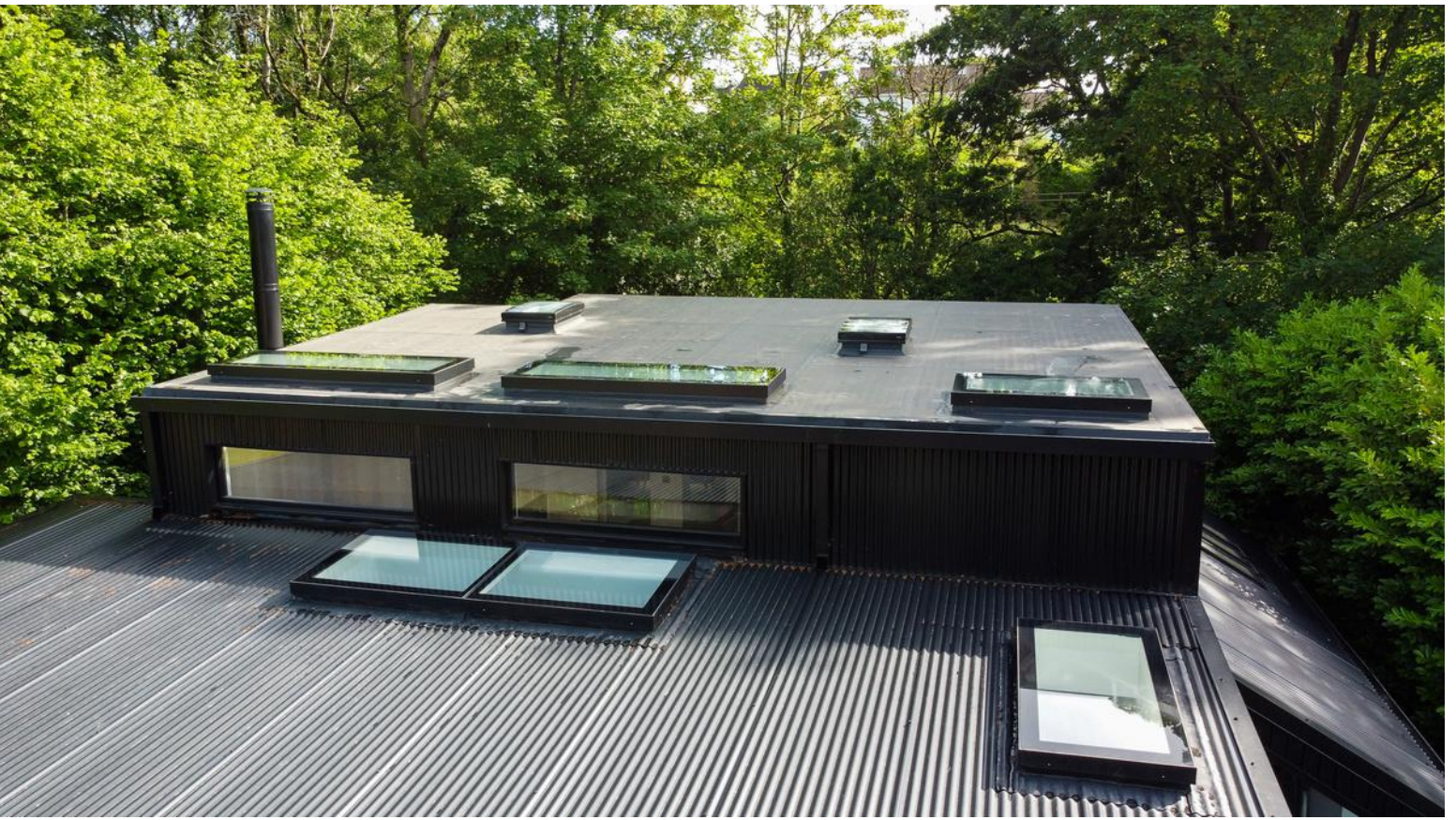

**Before Vario Rooflights**

**After Vario Rooflights**



# The Rectangular Rooflight



From

**£1,127\***

\*500 mm x 1000 mm,  
double layer IGU and  
150 mm upstand.  
Excl. Delivery.



Our rectangular window allows you to sculpt your space with natural light, highlighting your favourite spaces with generous bands of natural light.

The rectangular rooflight allows you to create a real wow factor in any room. With the possibility to enlarge this shape to an awe inspiring 4m<sup>2</sup> glass, if you can imagine it, we can build it. They offer the perfect combination of features for your lifestyle, including motorised ventilation, the best insulating glass, a walk-on function for roof terraces and other helpful features.





**Before Vario Rooflights**



**After Vario Rooflights**



**See sensational skies**

Add roof windows that deliver the wow factor. Open up your space with huge spans of sky that allow you to enjoy more light for longer and welcome nature into your home.



# The **Square** Rooflight



Enjoy symmetrical style with a statement square window that casts a beautiful, ever shifting light into your home. Dare to dream big, go for a large size and elevate your square window to appear almost as a glass ceiling, providing a powerful connection with the outside world. Alternatively, plan a smart pattern of smaller squares that will lend a charming dappled day-light effect to any room.

The square one can easily be installed almost anywhere in your house, allowing for a very flexible, functional window to the wider world. It can also come with a huge array of helpful features, such as highly insulating glass, motorised ventilation, walk-on capability for roof terraces and other great custom features.

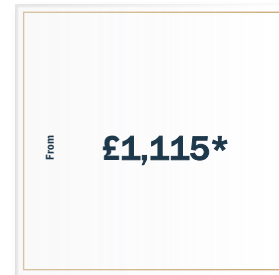

\*500 mm x 500 mm, double layer IGU and 150 mm upstand. Excl. Delivery.



## **Before Vario Rooflights**



## **After Vario Rooflights**

### **Find a natural rhythm**

Dial into the natural rhythm of the day. Open your space up to the sky and allow pools of light to move across the room during the day, creating a stunning natural effect.



# The **Unlimited** Rooflight



With absolutely no restriction in width, combine Unlimited number of modules with the freedom to fuse both fixed and opening operation, giving you the opportunity to enhance natural daylight and ventilation within your home. This rooflight can be configured to suit your space and style, with an impressive 4m<sup>2</sup> per module.

Try an Unlimited, bespoke rooflight for truly astonishing extensions and “hold the front page” hallway makeovers. Each individual module that makes up the full bespoke window span can be fitted with your choice of bespoke features for natural ventilation, insulation and more.

## **Before Vario Rooflights**



## **After Vario Rooflights**



## Enjoy unlimited light

Enjoy the true feeling of outdoors indoors as you create an endless span of daylight across your whole living space, where the sky's the limit and your imagination can roam free.

From		<b>£ 3,306*</b>
------	--	-----------------

\*3 x 513 mm x 600 mm. Total unlimited = 1800 mm x 600 mm, Double layer IGU and 150 mm upstand. Excl. Delivery.



# The **Walk-on** Rooflight



If you're looking to enrich the room below your roof terrace with some delightful daylight designs, then our walk-on window is for you. The walk-on window adds value above and below, providing a pretty feature in your roof terrace and flooding the room below with lots of beautiful natural light.

Choose the perfect shape and size for your light-filled vision, then add to your custom design with functional features such as an anti-slip pane, which ensures that it will not be dangerous to walk on the product when your roof terrace is wet.



## Create daylight connections

Whether it's letting the light in from the floor above or creating a stylish daylight design that compliments your roof terrace, this walk-on window does it all.



\*500 mm x 500 mm, double layer IGU and 150 mm up-stand. Excl. Delivery.





# The **Round** Rooflight



Create beautiful pools of natural daylight throughout your home with the help of round windows. Allow your imagination to fill each room with shafts of subtly shifting daylight, which gently alter the character of the space according to the natural rhythm of the day's passing.

Our circular window is a great way to add distinctive character to all kinds of spaces and what's more, you can add your choice of special features such as best in class insulation and much more to choose from, such as your choice of colours.

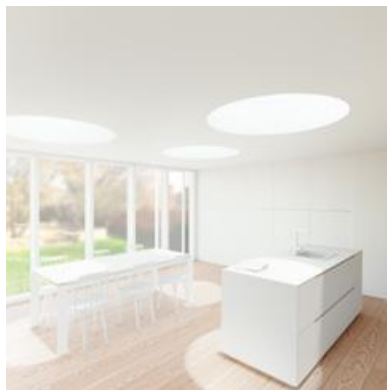

## **Pour light in**

Cast distinctive round pools of natural light as you create a really different daylight design, illuminating your space in a truly original way.

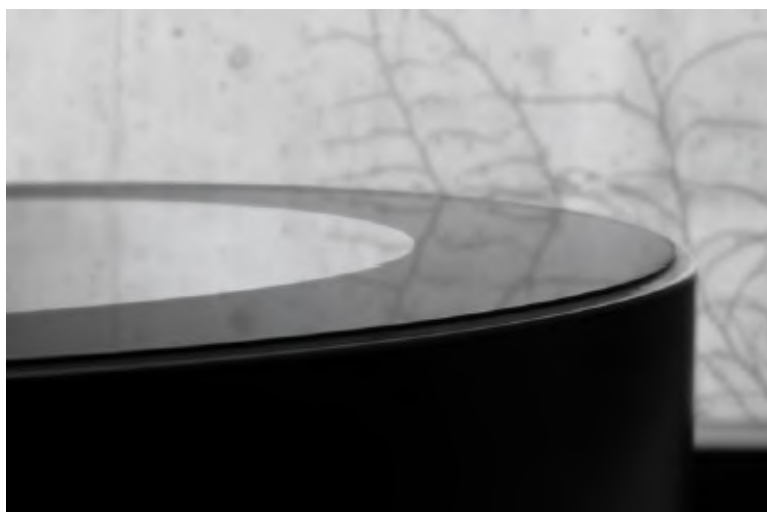

\*Ø 900 mm. Excl. Delivery.  
Excl. upstand.



**Before Vario** Rooflights

**After Vario** Rooflights



# The **Bespoke** Smart Blinds



The Vario by VELUX translucent roller blinds provide both light dimming while allowing you privacy making it the perfect choice for dining spaces, living rooms, home offices and playrooms. Blinds compatible with all Rooflights excluding Round. Product restrictions apply.



The Smart Blinds come in the following colours: Grey, White and Black.

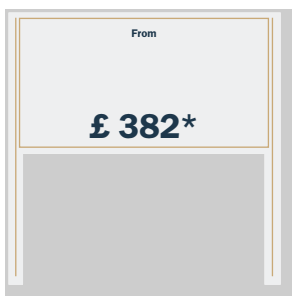
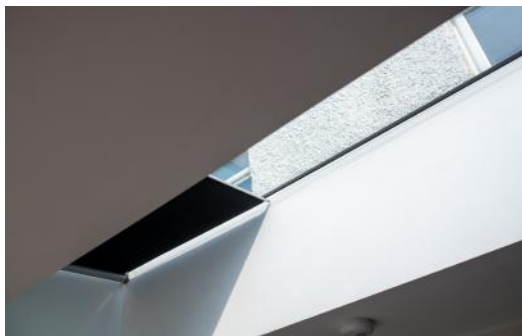

\*800 mm x 800 mm, internal roller blind. Excl. Delivery.



## **Plug and play**

The roller blinds can be pre-installed from the factory or retrofitted on already installed modules depending on the model.



## Smart Control

The new App control is included as standard when you buy blinds. With the VELUX App Control you can operate your opening windows and Smart blinds whether you're at home or on the go. All you need is your smartphone at hand.

Read more on page 32.

# Build Your Own Rooflight

We want to make your life easy when it comes to designing with daylight. Visit our website and try our Build Your Own configurator. Choose between colours, features, and more in a fun, intuitive and straightforward way.

The image displays a web-based configurator for rooflights. On the left, a configuration panel allows users to customize their rooflight. It includes a 'GO BACK' button, a 'How to measure correctly' link, and a diagram showing a rectangular rooflight with a length of 1300 and a width of 2500, resulting in a total area of 3.25 m<sup>2</sup>. Below the diagram, users can select various features:

- Operation:** Fixed, Opening (incl. rain sensor), Smart Opening (incl. rain sensor)
- Security:** Standard (basic security), Burglary Resistant (premium security)
- Glazing:** Double Layer, Triple Layer, Walk-on, Double Layer SP (with sun protection), Triple Layer SP (with sun protection), Walk-on Anti-slip
- Frame colour:** Jet Black (RAL9005), Traffic Grey (RAL7043), Custom colour (with an input field for 'Enter custom RAL')
- Upstand:** 150 mm, 300 mm

The right panel, titled 'The Rectangular One', shows a 3D rendering of the selected rooflight installed in a modern kitchen. Below the rendering are 'SHOW' and 'HIDE' buttons. At the bottom, the price is listed as 'Price ex. VAT £4,791', with 'QUICK QUOTE' and 'NEXT STEP' buttons.

Pick and choose your preferred features to create the ideal daylight solution for your home.

Be deliberately different.  
Create your own iconic daylight designs.  
Start here: [vario.velux.com/buildyourown](http://vario.velux.com/buildyourown)

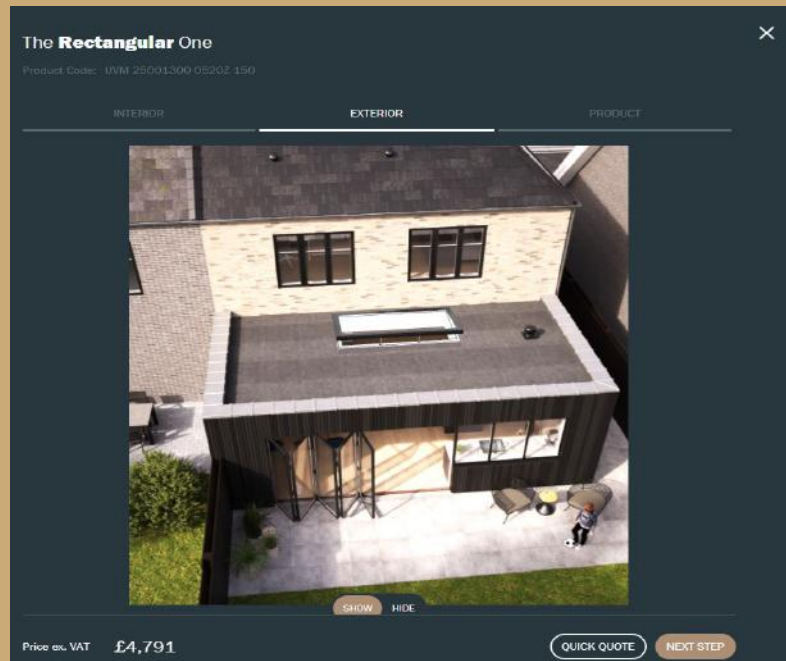

Change mode to see the solution from the outside.

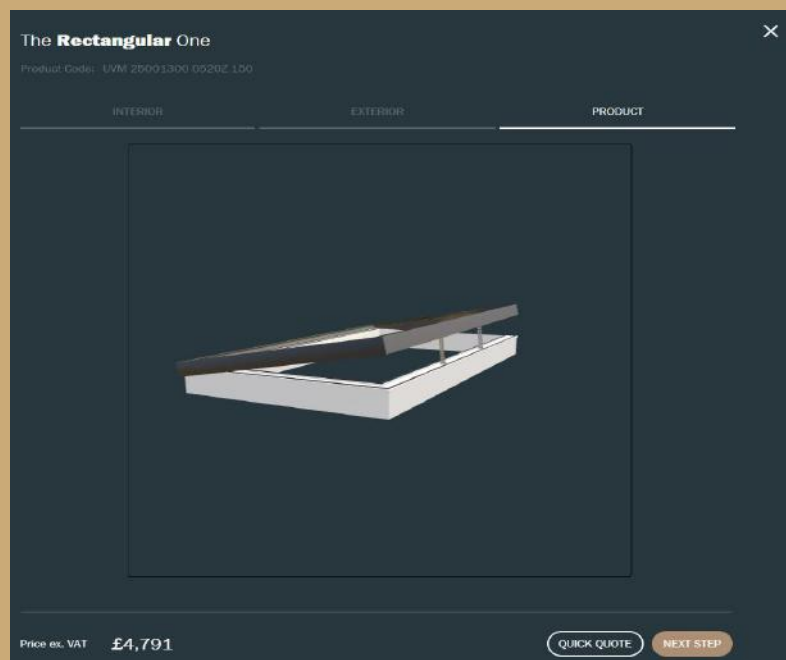

Change mode to see a 360 view of the product.

# Daylight Design Services

Vario by VELUX offers a range of services that will simplify the process of getting daylight and fresh air in from above

## Before the decision: Visualise your dream with the VELUX Daylight Experience

### Don't build blindly – Build With VELUX Daylight Experience

Let our Daylight Experts help you bring your drawings to life – we can help to convert your plan drawings into a real 3D render of your new house extension. The 3D renders will help you understand how rooflight will impact your home.

### This is how it works

Bring your project to life. Submit your drawings and mood board for the interior, consult with our Daylight Experts and agree on the potential, ideal daylight solution for your space.

### Envision the future

We'll provide you with a digital extension render of your space (worth £100) in 3 different versions

- Without rooflights
  - With bespoke rooflights in two different designs
- The renders include still images, videos of how the sun moves through your space and a panorama so you can truly experience your design virtually.



## Book Today/Find Out More

[hs-vario.velux.com/daylight-design-studio-extension](https://hs-vario.velux.com/daylight-design-studio-extension)

### From this:

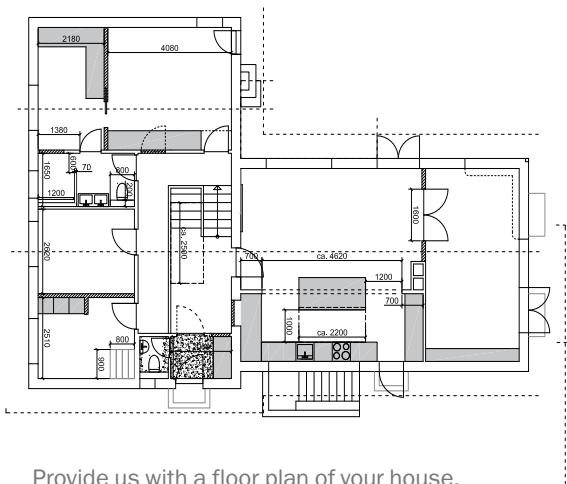

Provide us with a floor plan of your house. The more detailed description of your ideas, the better.

### To this:



Daylight Design 1



Daylight Design 2

## After the decision: Rooflight Installation, Replacement

Leverage our supply and fit service and let us handle the installation

Vario by VELUX has a small network of specialists that can support with with new installations of Vario by VELUX Rooflights and replacement installations, in select areas of the UK and Ireland.

Call us today at +44 (0) 1592 778 246 to book a site visit

**Book a visit from one of our experts:**

**<https://hs-vario.velux.com/vario-by-velux-book-a-site-visit>**



### Considering a Rooflight Replacement or need assistance with a New installation?

Do you need help replacing an old rooflight or roof whilst also adding a new rooflight?

We would gladly help you by reaching out to our professional network of contractors & Installers.

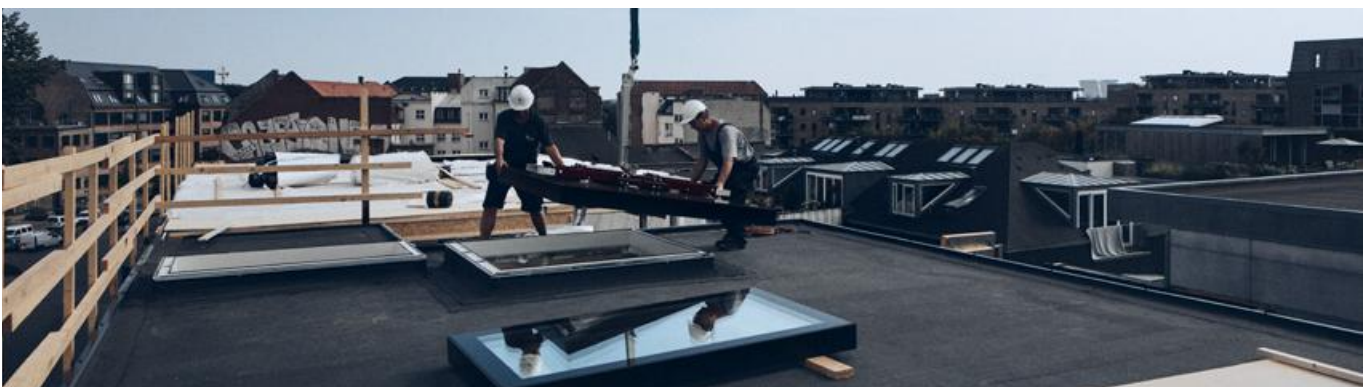

**Contact us today and we will guide you through a successful roofing project: <https://vario.velux.com/support/contactus>**



# Architect Suite

## Aspect & orientation

*"Change in light is a fundamental constant by which the human body maintains its relationship with the environment."*

– Alexander et al, *A Pattern Language*, 1977

By carefully considering the aspect and the orientation of your project, you will be able to visualise how the position of the sun interacts with the orientation of the building. You will see how cardinal directions (N, S, E, W) can influence the ways in which buildings receive daylight and learn how to harness the various effects that can occur in these differing contexts.

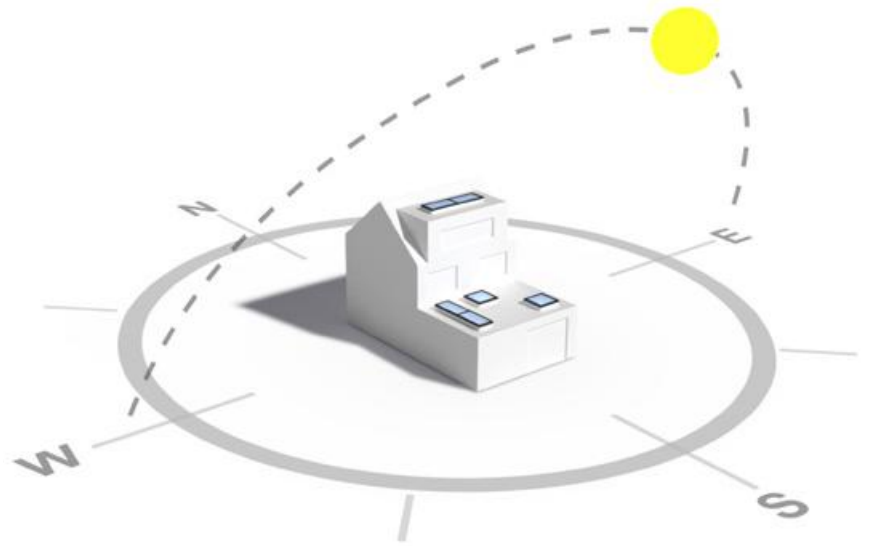

<https://vario.velux.com/architects-suite>

## Positioning of daylight through the roof



See how the positioning of rooflights in a space, completely transforms the atmosphere in the occupant's home.

Visit our useful tools section to become our Design Partner, get installation advice, speak to our Daylight Experts and much more.

Gather all important product details, to allow you to specify with ease.

## CAD/BIM objects & 3D drawing tools

### Use drag and drop objects

Start designing your rooflight solution with our CAD/BIM objects of the Vario by VELUX range. All 3D objects can be downloaded for REVIT, ARCHICAD and Trimble SketchUp. You will also find cross sections in .pdf & .dwg formats for all rooflights. The object families are built in accordance with buildingSMART, including: COBIE, CCS and Omni class.



AUTODESK  
REVIT



GRAPHISOFT  
ARCHICAD

SketchUp

bimobject

Objects can be downloaded from **BIMObject.com**

[www.bimobject.com/en-us/velux-v](http://www.bimobject.com/en-us/velux-v)

 NBS Source

Vario by VELUX product range is also available on NBS Source

## CPD

Our RIBA approved Vario by VELUX CPD is now available. Call us to get more information and book an appointment.



**Book a CPD here:**  
[vario.velux.com/cpd/book](http://vario.velux.com/cpd/book)

# Specification

## What is the difference between clear internal and external kerb?

### Actually it is 56% more daylight!

We use the Clear Internal measurement, which equals to the amount of natural light you'll get, after having finished the installation.

The difference between the external kerb measurement and the clear internal measurement is that by choosing external kerb measurement, the amount of daylight getting in will be significantly less.

For a clear internal rooflight of 1000mm x 1000mm, the external upstand measurement would be 800mm x 800mm, meaning that you will actually get 200mm more daylight by simply specifying Vario Rooflights and using our clear internal dimensions.

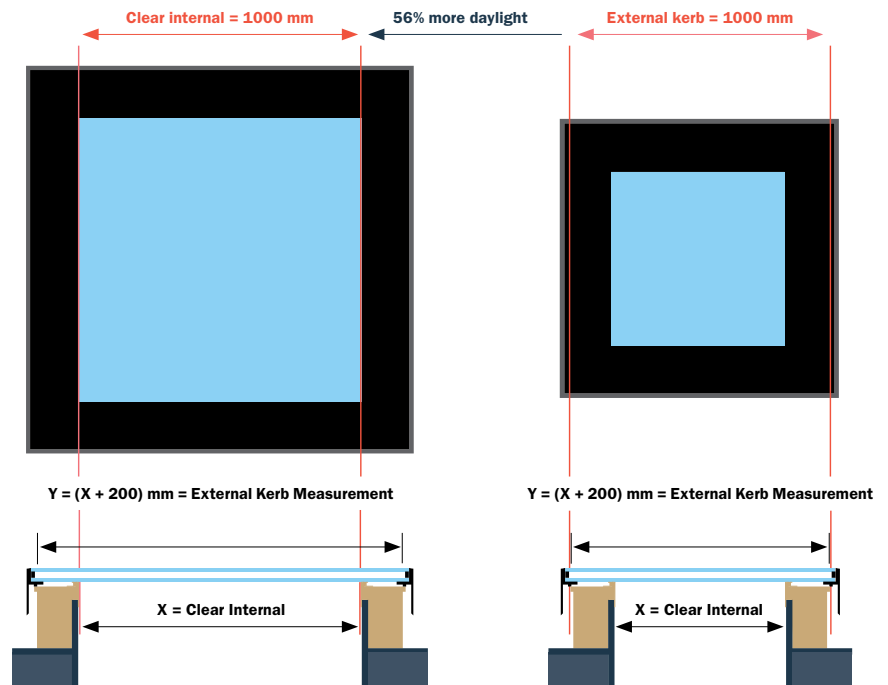

## Installation pitch

Vario by VELUX can be installed in roof pitches from 0° up to 15°. A minimum of 5° installation pitch is recommended to avoid ponding water on the glass surface.

Our opening rooflights are top-hung meaning that the hinges should be placed at the highest point, whereas the actuator

should be placed at the lowest point of the roof pitch. On the below illustration you see how the length of the rooflight follows the slope of the roof, whereas the width is where the actuator is integrated. Correct installation is important for maintaining the 10 Year Rooflight Guarantee that we offer.

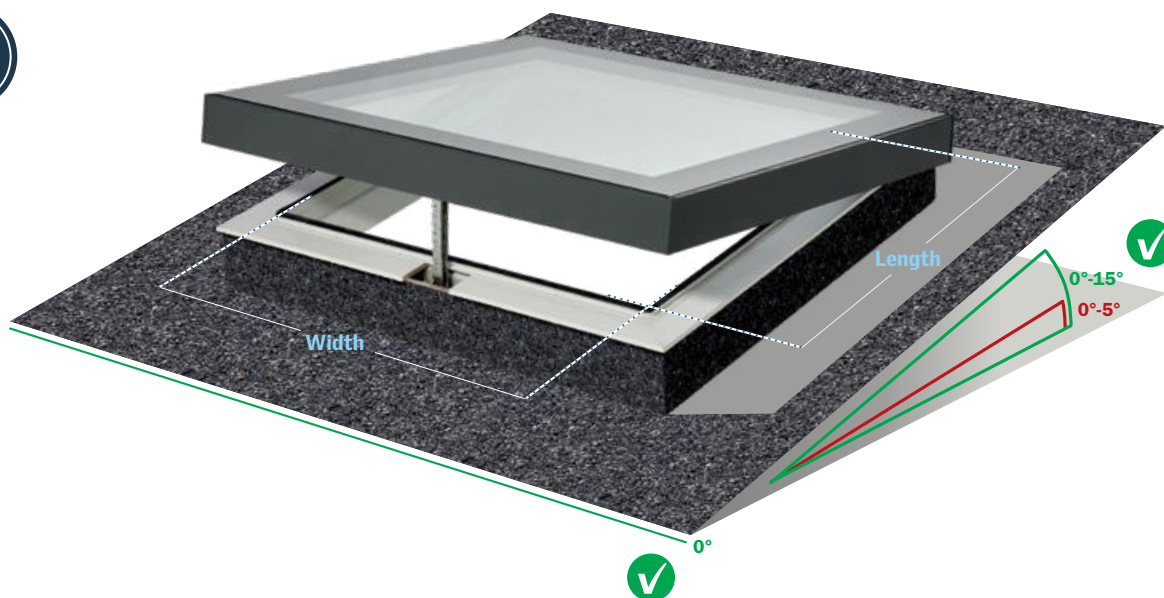

# Sectional Drawings

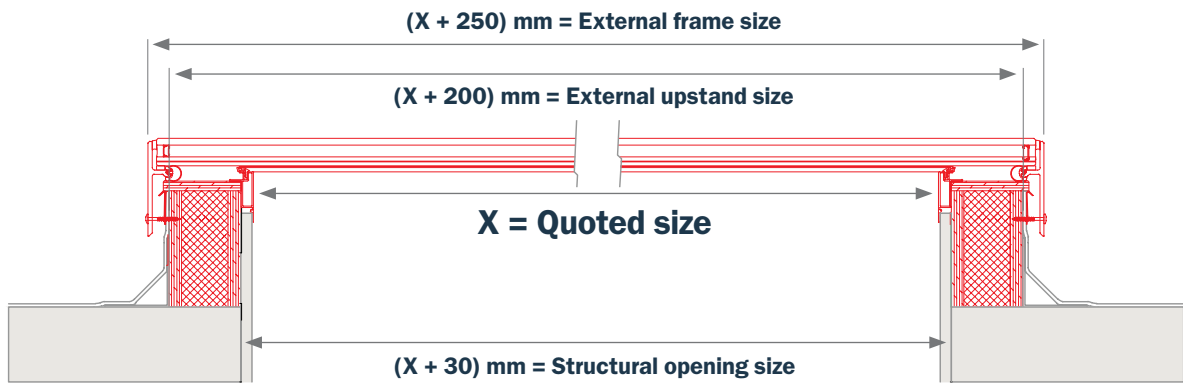

## Detail of the sectional drawing

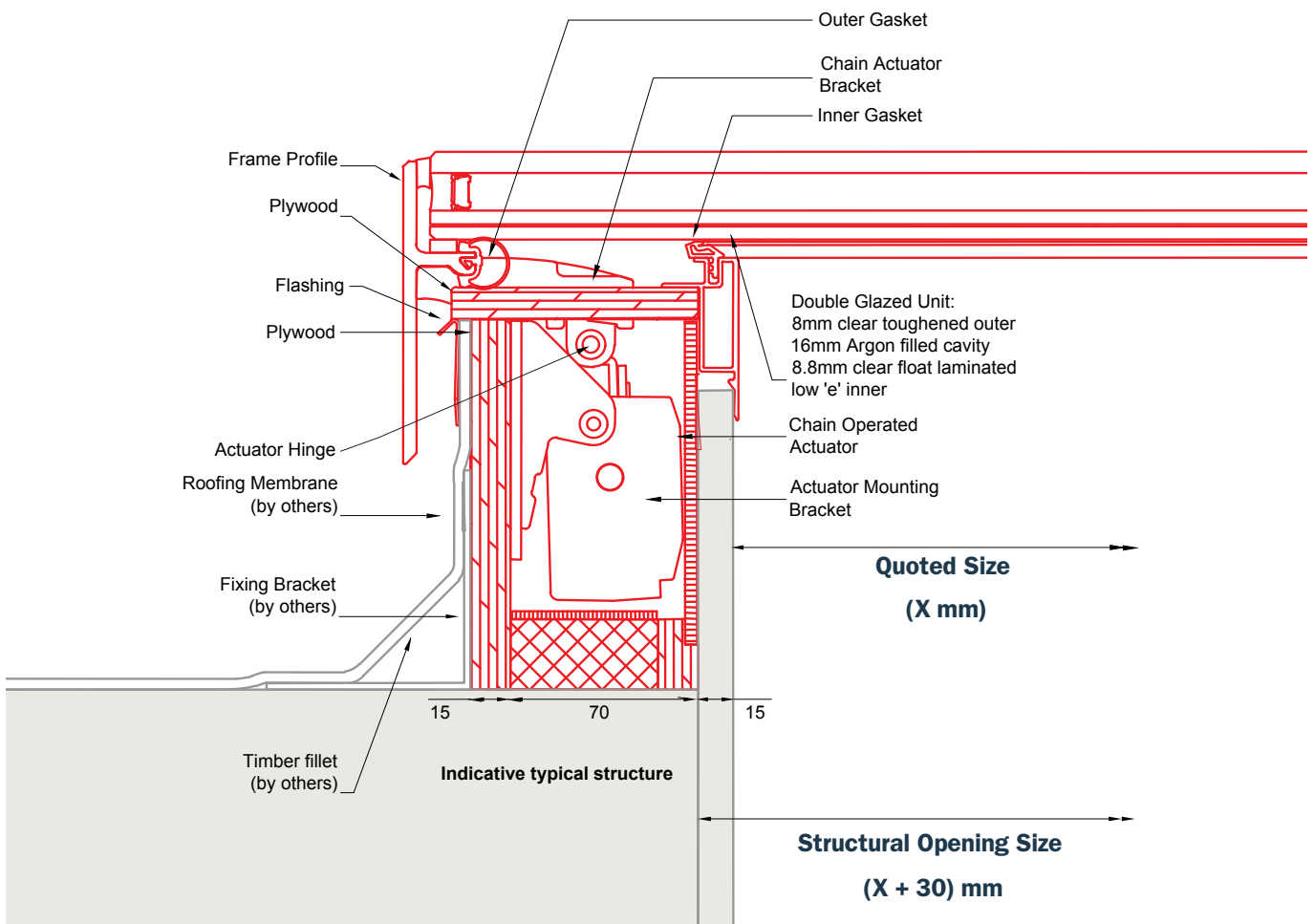

Objects can be downloaded from [BIMObject.com](http://BIMObject.com)  
[www.bimobject.com/en-us/velux-v](http://www.bimobject.com/en-us/velux-v)

# Installation

## Installation tools

Everything in its right place with no hassle. When we claim full support for product advice and installation guidance, we mean it. We provide comprehensive installation guides to put in your new Vario by VELUX window. If in doubt – call us.

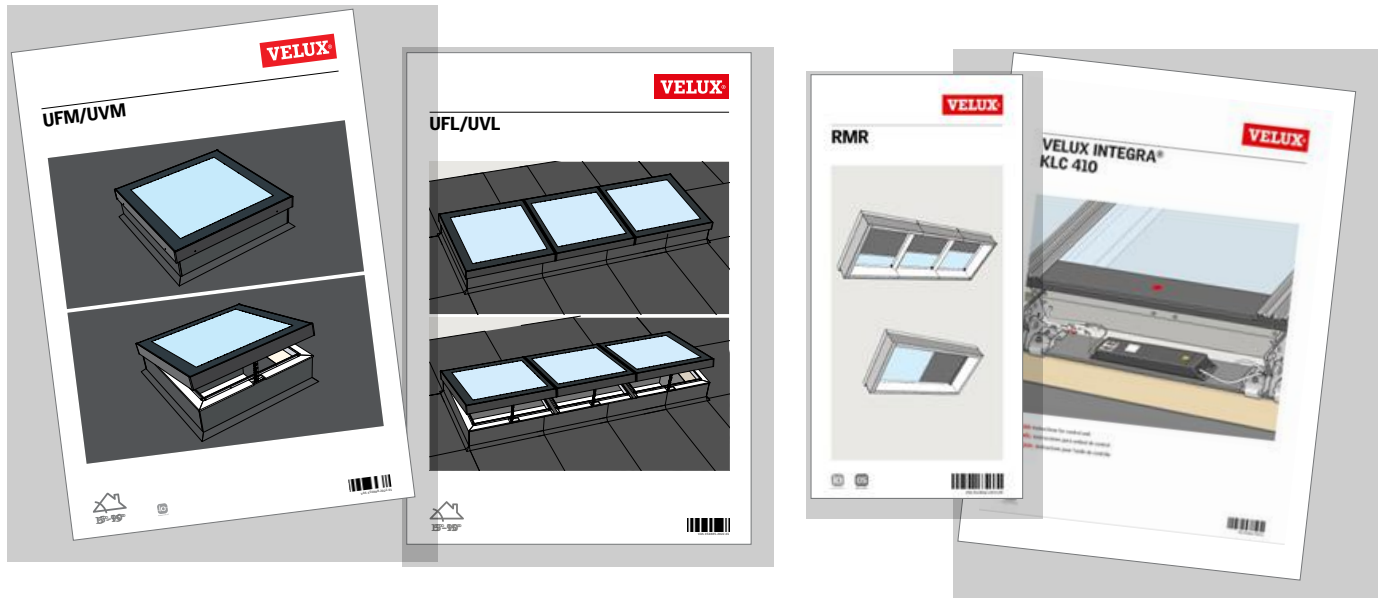

## Find what you need:

[vario.velux.com/downloadcentre/installationguides](http://vario.velux.com/downloadcentre/installationguides)

## Installation videos

For all our roof windows we have made "How to" installation videos. Easy to approach, easy to install.

**All you have to do is to scan the QR-code to the right:**



## Guarantee

**10 years on the modules**

**3 years guarantee on electrics and blinds**

Our Vario by VELUX rooflights are supported by a 10-year guarantee. Actuators and other electrical components that are a part of the product solution come with a 3-year guarantee.

The guarantee is subject to correct installation and usage.



## Want to know more:

[vario.velux.com/support/veluxguarantee](http://vario.velux.com/support/veluxguarantee)

# Product Construction



## The fixed rooflight

Our fixed rooflights are ideally suited to rooms where daylight is the only priority and spaces like roof terraces where an opening window wouldn't work.



## The opening rooflight

Our opening rooflights provide the double health benefits natural light and ventilation. They are an elegant and functional solution, with a fully integrated chain actuator concealed within the wooden upstand. The rooflight opens around 260 mm.

## These windows offer an opening option



The **Long Slim** Rooflight



The **Rectangular** Rooflight



The **Square** Rooflight



The **Unlimited** Rooflight



# Product Limitations

Glazing unit**	Clear internal measurements (mm)		Upstand (mm)		Limitations						
	Width (B) (Actuator side) Diameter (Ø) (only Circularlight)	Length (A) (Slope direction)	Height	Construction width	Max. clear internal area (m <sup>2</sup> )	Max. measurement of shortest side (mm)	Max. ratio between shortest and longest side	Clear internal area (m <sup>2</sup> ) or width (B) in relation to one or two actuators	Min. width (B) for two actuators (mm)		
The Long Slim One											
The Rectangular One	Fixed	DG	250-3000	250-3000	150-600	100	4.00	1600	1:6	–	–
The Square One											
The Long Slim One											
The Rectangular One	Fixed	TG	250-3000	250-3000	150-600	100	4.00	1600	1:6	–	–
The Square One											
The Long Slim One											
The Rectangular One	Opening	DG	600-3000	600-2000	150-600	100	4.00	1600	1:6	Area ≤ 2 m <sup>2</sup> (One actuator) Area > 2 m <sup>2</sup> or width (B) > 2m (Two actuators)	1200
The Square One											
The Long Slim One											
The Rectangular One	Opening	TG	600-3000	600-2000	150-600	100	3.00	1600	1:6	Area ≤ 1,5 m <sup>2</sup> (One actuator) Area > 1,5 m <sup>2</sup> or width (B) > 2m (Two actuators)	1200
The Square One											
The Unlimited One	Fixed	DL	250-3000	250-2000	150-600	100	4.00	1600	1:6	–	–
The Unlimited One	Fixed	TG	250-3000	250-2000	150-600	100	4.00	1600	1:6	–	–
The Unlimited One	Opening	DG	600-3000	600-2000	150-600	100	4.00	1600	1:6	Area ≤ 2 m <sup>2</sup> (One actuator) Area > 2 m <sup>2</sup> or width (B) > 2m (Two actuators)	1330
The Unlimited One	Opening	TG	600-3000	600-2000	150-600	100	3.00	1600	1:6	Area ≤ 1,5 m <sup>2</sup> (One actuator) Area > 1,5 m <sup>2</sup> or width (B) > 2m (Two actuators)	1330
The Walk-on One	Fixed	WG	250-2000	250-2000	150-600	100	2.00	–	1:6	–	–
The Round One	Fixed	DG	Ø 900-1350	Ø 900-1350	–	TP*	1.43	–	–	–	–

\* Topplate-107

\*\* Double Glazing = **DG**, Triple Glazing = **TG**, Walk-on Glazing = **WG**

\*\*\* Depends on snow and wind load - use static calculator

# Product Add Ons

## VELUX ACTIVE®

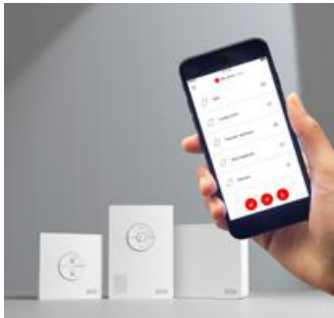

VELUX ACTIVE® is a Smart Home addition that ensures healthy indoor climate and smartphone operation

VELUX ACTIVE® with NETATMO is the easy way to a healthier indoor climate. Smart sensors continuously monitor the temperature, humidity and CO<sub>2</sub> levels in your home and open or close your Vario by VELUX opening rooflights to create a healthier indoor climate.

- Sensor-based ventilation: Smart sensors continuously monitor temperature, humidity and CO<sub>2</sub> levels and open or close your roof windows accordingly.
- Stay in control: Use the VELUX ACTIVE® app to operate your Vario by VELUX rooflights from anywhere using your smartphone.
- Easy installation: VELUX ACTIVE® indoor climate control can be installed without any professional help.

## The automation hardware



**VELUX ACTIVE®**  
Smart Home addition, which ensures a healthy indoor climate and smartphone operation



**KLI 311/312**  
Wireless remote control



**KLA 200**  
Wired rain sensor



**KLC 410**  
Control unit

**All above single units are included when buying an opening product**

## Sun protection glazing

Having too much heat or light enter through your rooflight can present as much of a problem as trying to keep heat in. Our solar control glazing offers efficient heat reduction, as it blocks up to 69% of the heat gain. The human eye will easily compensate

for the reduced light transmittance, which is approx. 20% less than our LowE glazings. There will be no green/blue tint in the glazing, merely a darker luminance. For full insulating glazing table go to: [vario.velux.com/downloadcentre/otherdocumentation](http://vario.velux.com/downloadcentre/otherdocumentation)



Double layer glazing with low emissivity coating (LowE) and with a light transmittance of 80%.



Double layer glazing with Sun coating (Sun) and with a light transmittance of 61%.

## Burglary resistance



### Upgrade the security of your rooflight

If you want to enhance the security of the rooflight or need to be compliant with building legislation, we offer a burglary resistance upgrade to your rooflight. To be burglary resistant, the rooflight has been upgraded with a

set of key features that will make breaking the rooflight open significantly harder.

Our burglary resistance rooflight design has been tested according to the EN 1627:2011 & NEN 5096:2012+A1:2015: Class 2 (RC2)

## Roller blinds



The internal Smart blind is designed for installation with Vario by VELUX modules. The blind protects against heat and glare and helps to control the amount of light in the building. The roller blind is available for **Long Slim-, Rectangular-, Square-** and **Unlimited** Rooflights both fixed and venting, including burglary-resistant modules and walk-on rooflights.

To support fast and safe installation, our rooflights come with hidden pre-wiring and is pre-installed from the factory if you buy with your order, except for burglary-resistant & walk-on modules. The roller blinds can also be retrofitted on already installed modules – get in contact to hear more.

Vario by VELUX Smart blinds are electrically operated and can be controlled using either VELUX INTEGRA® or Open System ±24V (OS ±24V DC).

### Operation

One power supply and control unit KLC 410 can control up to four Roller blinds. Smart blinds RMR can be operated from either one of the following or a combination of:

- App control (KIG 300)
  - individual or simultaneous control from a with smartphone.
  - The KIG 300 can be upgraded at any time to the more comprehensive VELUX ACTIVE®
- Wireless remote control (KLI 312)
  - simultaneous operation

**The KIG 300 is included as standard when buying a Smart blind**

### Order the right size

To order the right sizes see the roller blind limitations underneath.



### Limitations on roller blind sizes

The roller blind is available in any height from 725 mm till 3000 mm and in width from 600 mm till 1000 mm.

It can be oriented in the top-bottom or side-side direction of the rooflight.

### Fire retardant sun screening included in the roller blinds

The Smart blinds is made in a lightweight polyester fabric and are available in three commonly used colours. The fabric is fire retardant.



Grey:  
RMR 8805



White:  
RMR 8806



Black:  
RMR 8807



# The Tech Stuff

## Wooden upstand

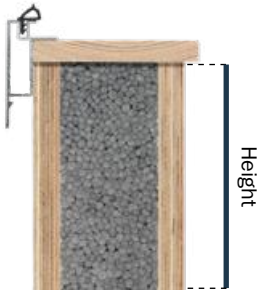

The wooden upstand is supplied in either 150, 300 and 450mm, fully insulated with EPS Foam. Depending on project requirements, or visual architectural ideas, if other heights are needed, please contact our Daylight Experts.

## Material – finish & colours

### External frame (External surface)

Material: Aluminium (5 mm)  
Surface: Powder coated



Colour: RAL 9005,  
gloss 30 (Jet black)  
Free selective



Colour: RAL 7043,  
gloss 30 (Traffic grey)  
Free selective



Colour: CUSTOM RAL,  
(Evaluated upon request)  
Extra fee

### Wooden upstand (Internal surface)

Material: Wood and insulation  
Internal surface and top: Water-resistant pine wood, Waterbased white coating  
External surface: Water-resistant plywood untreated



Colour: RAL 9010,  
gloss 30 (Pure white)

## The construction

- Applies to all our rooflights
- Applies to all opening rooflights
- Applies to the Unlimited One

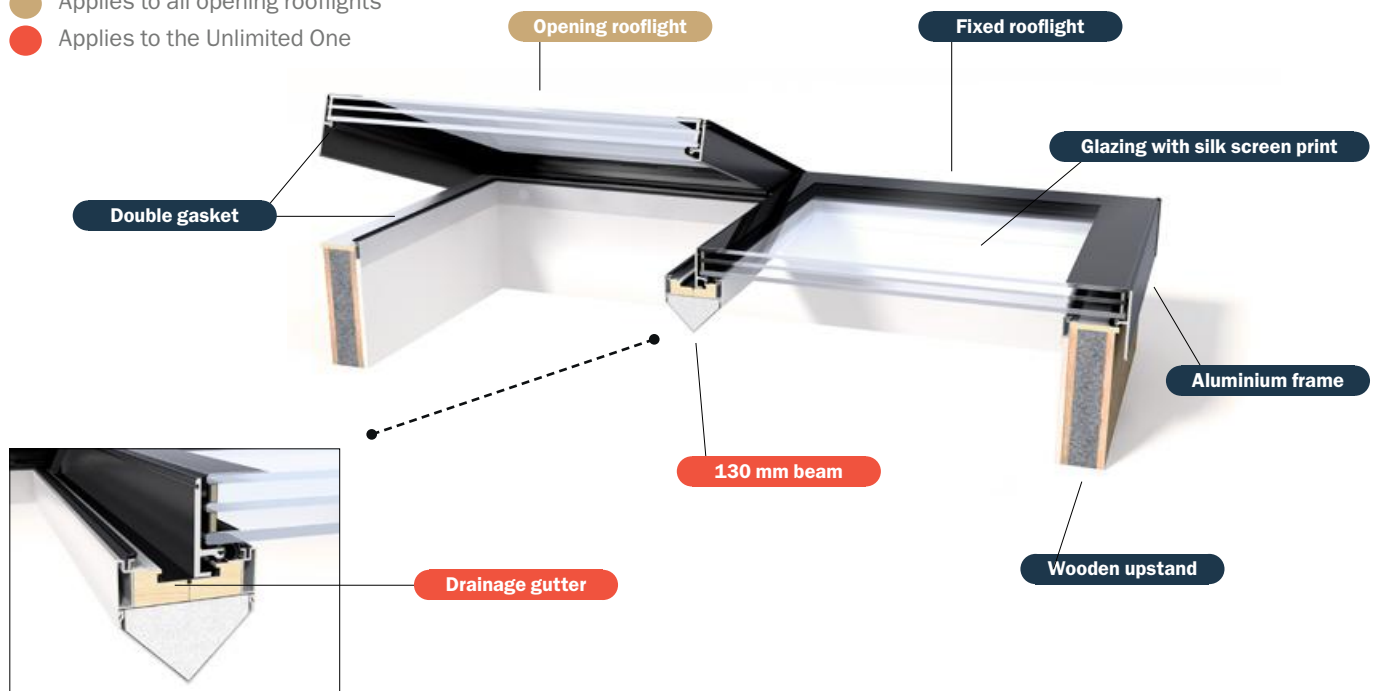

## Installation of control unit (KLC410)

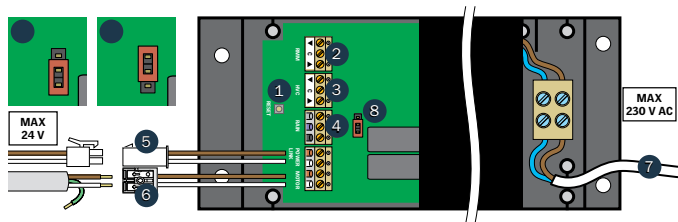

**IMPORTANT!** After pairing with the remote control, connect the actuator chain with the top unit using the locking pin. Now, calibrate the control unit by fully opening and closing the window using the remote.

### Control unit (connection plan)

- 1 RESET-button for registration of control or potential-free switch. After a long press (6-10 sec) registration in control must take place within 10 min.
- 2 Potential-free entry for roller blinds
- 3 Potential-free entry for chain actuator
- 4 Entry for rain sensor KLA 200
- 5 Plug connector for roller blinds
- 6 Plug connector for chain actuator
- 7 230 V AC, consumption max 250 W
- 8 Jumper for compulsory chain actuator detection

## Rooflight weight

- Double glazing incl. upstand
- Triple glazing incl. upstand
- Walk-on rooflight incl. Upstand

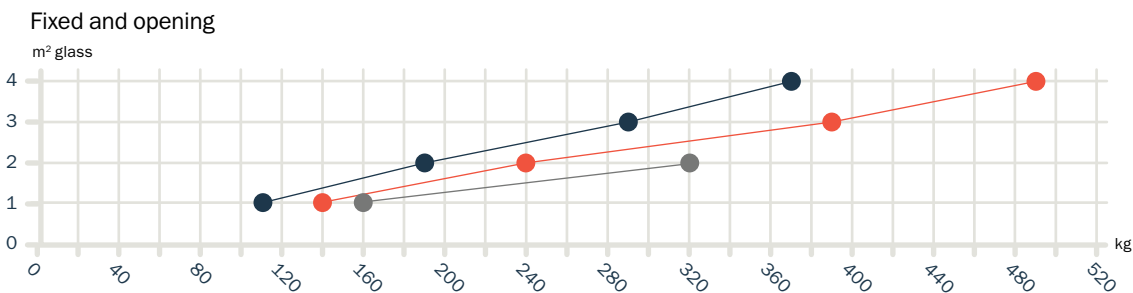

## Chain actuator for opening solutions

In opening rooflights, the actuator is fully integrated in the wooden upstand. The actuator is not visible from the inside when the rooflights are closed, thus there is no visual difference between fixed and opening rooflights. An opening product is operated by either 1 or 2 actuators depending on the clear internal area and the rooflight's width.

### Components included:

- The control unit and wireless controls are part of the opening rooflights and included in the price
- Wiring from the actuator is included
- Rainsensor is included (Wiring by others)



### No. of actuators

Glazing – Double or Triple	Double Glazing		Triple Glazing	
	≤ 2000 mm	> 2000 mm	≤ 2000 mm	> 2000 mm
Width measurement (actuator side)	≤ 2000 mm	> 2000 mm	≤ 2000 mm	> 2000 mm
Clear internal area – max.	≤ 2 m <sup>2</sup>	> 2 m <sup>2</sup> ≤ 4 m <sup>2</sup>	≤ 1,5 m <sup>2</sup>	> 1,5 m <sup>2</sup> ≤ 3 m <sup>2</sup>
No. of actuators* integrated in upstand	1	2	1	2

# The Tech Stuff

**Insulating glazing unit (IGU)** Double Glazing = **DG** Triple Glazing = **TG** Walk-on Glazing = **WG** Walk-on Anti-slip Glazing = **WAG**

Glazing	Coating	IGU code	Clear internal area a (m <sup>2</sup> )	Thermal transmittance (rooflight) U <sub>w</sub> value [W/(m <sup>2</sup> K)]		Thermal transmittance (glazing) U <sub>g</sub> value* [W/(m <sup>2</sup> K)]
				Window size < 2,3 m <sup>2</sup>	Window size ≥ 2,3 m <sup>2</sup>	
<b>DG</b>	LowE	20V	a ≤ 2 m <sup>2</sup>	1.7	–	1.1
<b>DG</b>	LowE	20Y	2 m <sup>2</sup> < a ≤ 2.8 m <sup>2</sup>	1.7	1.6	1.1
<b>DG</b>	LowE	20Z	2.8 m <sup>2</sup> < a ≤ 4.0 m <sup>2</sup>	–	1.8	1.1
<b>TG</b>	LowE	30V	a ≤ 2 m <sup>2</sup>	1.2	–	0.5
<b>TG</b>	LowE	30Y	2 m <sup>2</sup> < a ≤ 2.8 m <sup>2</sup>	1.2	1.1	0.5
<b>TG</b>	LowE	30Z	2.8 m <sup>2</sup> < a ≤ 4.0 m <sup>2</sup>	–	1.2	0.6
<b>WG</b>	LowE	25V	a ≤ 1 m <sup>2</sup>	2.0	–	1.3
<b>WG</b>	LowE	25Y	1 m <sup>2</sup> < a ≤ 1.5 m <sup>2</sup>	2.0	–	1.3
<b>WG</b>	LowE	25Z	1.5 m <sup>2</sup> < a ≤ 2.0 m <sup>2</sup>	2.0	–	1.3
<b>DG</b>	Sun1	21V	a ≤ 1 m <sup>2</sup>	1.7	–	1.0
<b>DG</b>	Sun1	21Y	1 m <sup>2</sup> < a ≤ 1.5 m <sup>2</sup>	1.7	1.6	1.0
<b>DG</b>	Sun1	21Z	1.5 m <sup>2</sup> < a ≤ 2.0 m <sup>2</sup>	–	1.8	1.2

The glazing unit has a 115 mm black silk screen print along the edge.  
\* Slope α = 90°

Glazing	Coating	IGU code	Construction (outside - inside)	Solar factor g-value (%)	Light transmittance τ <sub>v</sub> (%)	Acoustic performance dB
<b>DG</b>	LowE	20V	8H - 16 argon - 44.2 Low E	61	80	37 (-1,-5) dB
<b>DG</b>	LowE	20Y	8H - 14 argon - 55.2 Low E	61	80	39 (-2,-5)dB
<b>DG</b>	LowE	20Z	8H - 12 argon - 66.2 Low E	61	79	38 (0,-4)dB
<b>TG</b>	LowE	30V	8H - 18 argon - 6H Low E - 18 argon - 55.2 Low E	53	71	45 (-2,-4) dB
<b>TG</b>	LowE	30Y	8H - 16 argon - 6H Low E - 18 argon - 66.2 Low E	52	71	45 (-1,-4) dB
<b>TG</b>	LowE	30Z	8H - 15 argon - 6H Low E - 15 argon - 88.2 Low E	52	70	44 (-1,-3) dB
<b>WG</b>	LowE	25V	6.8.8H - 16 Air - 44.2 Low E	50	74	36 (-1; -4) dB
<b>WG</b>	LowE	25Y	8.8.8H - 16 Air - 55.2 Low E	49	73	36 (-1; -4) dB
<b>WG</b>	LowE	25Z	8.10.8H - 16 Air - 55.2 Low E	49	73	36 (-1; -4) dB
<b>DG</b>	Sun1	21V	8H Sun1 - 16 Argon - 8.76F LowE (44.2)	33	61	37 (-1,-5) dB
<b>DG</b>	Sun1	21Y	8H Sun1 - 14 Argon - 10.76F LowE (55.2)	33	61	39 (-2,-5) dB
<b>DG</b>	Sun1	21Z	8H Sun1 - 12 Argon - 12.76F LowE (66.2)	33	60	38 (0,-4) dB

## Performance example for opening 1500x1500 triple layer IGU

Product code: UVM 15001500 0530Y 150 18BI05

Essential characteristics	Performance	§	NB*
Resistance to wind load	Class C5	4.2	1235
Resistance to snow load	8 mm float - 16 mm - 6 mm float - 18 mm - 12.76 mm (66.2) laminated float	4.3	-
Reaction to fire	Class B-s1,d0	4.41	0402
External fire performance	NPD	4.42	-
Watertightness	Class E1200	4.5	1235
Impact resistance	Class 4	4.7	1205
Acoustic performance	36 (0; 3) dB	4.11	-
Thermal transmittance	1.2 W/m <sup>2</sup> K	4.12	1235
Solar factor	0.52	4.13	-
Light transmittance	0.71	4.13	-
Air permability	Class 4	4.14	1235

NPD: No performance determined

\* Notified body/ies: <http://ec.europa.eu/growth/tools-databases/nando/>



Get all performance figures through our CE marking configurator:  
[velux.co.uk/help-and-advice/cemarking](http://velux.co.uk/help-and-advice/cemarking)

## Glazing unit with low emissivity coating and Smart blind RMR

Double Glazing = DG

Glazing	Coating	IGU code	Smart blind	Light transmittance $\tau_v$ (%)	Solar factor g-value (%)
DG	LowE	20V	RMR 8806, White	30	34
DG	LowE	20Y	RMR 8806, Grey	8	41
DG	LowE	20Z	RMR 8806, Black	1	35

# Don't Take Our Word For It, Trust Trustpilot:

## Vario by VELUX

Reviews 53 • Excellent



4.7 ⓘ

**RU Russell**  
1 review • GB

★★★★★ Verified 13 Apr 2022

**Outstanding**

From the outset the service, information and support has been outstanding. We will be using the Vario service for all rooflights from now on.

Each time I work with Velux it confirms that the exceptional characteristic is inherent throughout everyone.

It's a pleasure to do business with you.

**Date of experience:** 13 April 2022

Useful Share Reply

**AL All**  
1 review • GB

★★★★★ Verified 25 Nov 2022

**Special thanks to Angela and Jason!**

Angela and Jason were both very helpful to us with all the technicalities and follow up points since we fitted our flat skylight window and electric solar blind to our garden extension roof. They also helped us a great deal to arrange certified Velux fitter, who did a great job as well. I highly recommend anyone, who is planning for renovations or extensions and thinking skylight windows, to work with Vario by Velux Team, because they are very reliable and helpful with all the products and process. Thanks Vario Team!

**Date of experience:** 25 November 2022

Useful Share Reply

**LM Louisa Murgatroyd**  
14 reviews • GB

★★★★★ Verified 22 Sept 2022

**Rooflight solutions**

Rooflight solutions

I was sourcing rooflights for a new extension, and given the hot summer was looking for some that looked good, provided ventilation and also shade. Vario provides all these solutions, with a tailor made approach to what you need. Their customer services are second to none. Always happy to help, and talk things through, and I couldn't be happier with the solution we have found thanks to Vario.

**Date of experience:** 01 September 2022

Useful Share Reply

**PC Patricia Coughlan**  
3 reviews • US

★★★★★ 28 Mar 2022

**Excellent, Efficient Service**

Hello there, I wish to recommend the service that the Vario service team at Velux provided to us. They were extremely helpful, providing written instructions for installation for our engineer and builders to study. If their technical experts were unavailable, they returned our calls the following day. We had a particularly large triple glazed velux unit to install weighing close to 400kg and as I said all the staff seemed to be very keen to know if the installation went well. I think this gave us great confidence and trust in this company and we would certainly use them again. You also got the feeling if there was a problem, they would do their best to help and not run for the hills...thank you Tim & Trish Coughlan, West Cork, Ireland

**Date of experience:** 28 March 2022

Useful Share Reply

**JA Jeanette Armstrong**  
2 reviews • GB

★★★★★ Verified 21 Jul 2022

**Lovely helpful staff**

Excellent service & everyone was very helpful in the run up to ordering with help regarding measurements & window details.

**Date of experience:** 21 July 2022

Useful Share Reply

**NY Nick Yoward**  
9 reviews • GB

★★★★★ Verified 21 Dec 2022

**Excellent service**

Excellent service & backup when I damaged the original walk on skylight

**Date of experience:** 16 September 2022

Useful Share Reply

# Get Your Own Bespoke Rooflight

**Get in touch!**

**Daylight Experts:**

**Call us at +44 (0) 1592 778 246  
or write us an email at [vario@velux.co.uk](mailto:vario@velux.co.uk)**

**Imagine, design & get your own  
Try our configurator at [vario.velux.com/buildyourown](https://vario.velux.com/buildyourown)**

Visit our social channels for more inspiration:



We're here to support you with your rooflight design and purchase in any way we can.  
All you have to do is ask our Daylight Experts!

